

Data Sheet

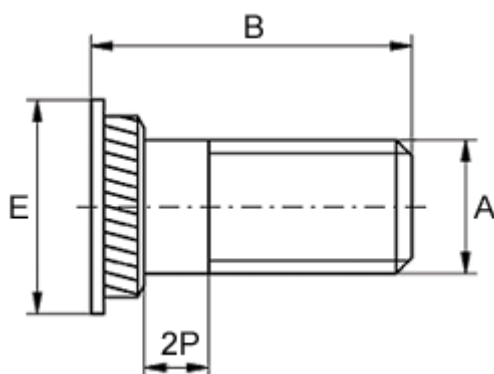

Article number: 12514700040500
Description: KLEE-coil 514 700 040.500
M4 Stainless 14305

Measures



For plate thickness, min	= 1.5
Head diameter E	= 7
Hole diameter +0.1	= 6.4
Length B	= 14
Male thread A	= M4x0,7
Min distance to edge	= 3.3